

Platz für Wechsel des Containers

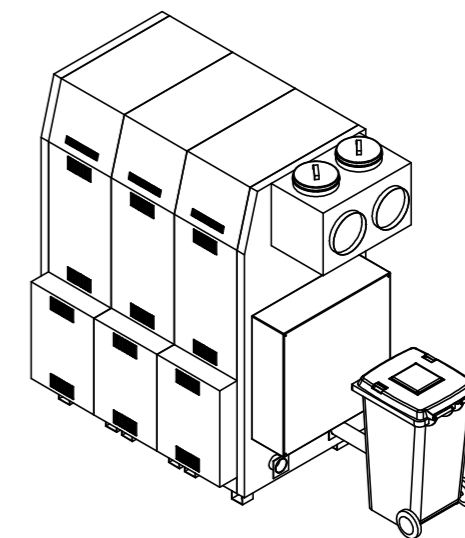
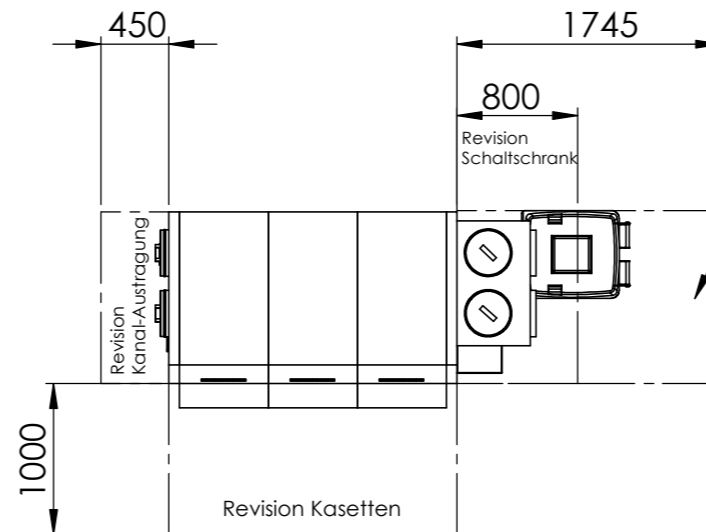

Allgemeintoleranzen nach DIN ISO 2768 mittel

Rev	Änderung	Datum	Name	Firma:			Titel:		Revision:	
				OekoSolve			M D200			
				OekoSolve AG Schmelzweg 2 CH-8889 Plons +41 81 511 63 00 www.oekosolve.ch			3M			
					Name:	Datum:	Nummer:		Dokumentenart:	
						03.06.2019	102049219			
				Erstellt:			Gewicht:	Material:		
				Freigegeben:			0.00			
				Status:	IN ARBEIT		Datei:	Maßst.: 1:50	Format: A3	Blatt: 2/6
							CAD-019786			